

Inductive Sensors
BES 516-300-S 300-S 4-D
M12x1 x 93
normally-open
Sn=1,5mm
shielded
pressure rated to 500 bar

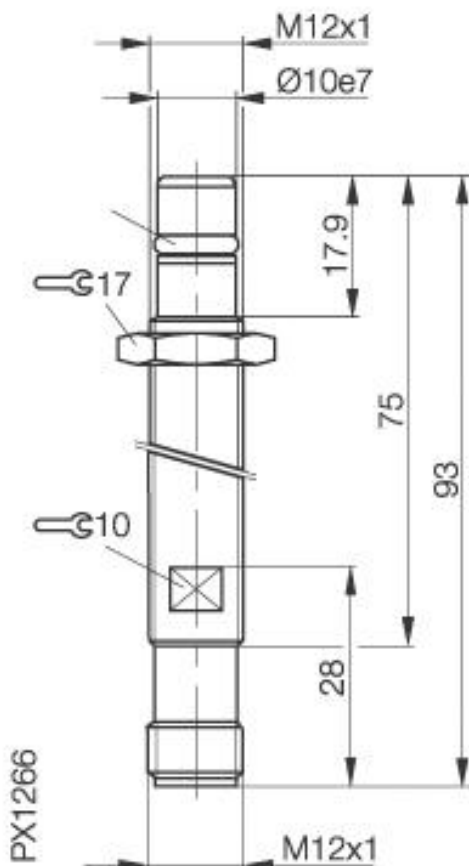

Common Data

Mounting in steel	shielded
Rated operating distance Sn	1,5mm
Assured operating distance Sa	0...1.2mm
Repeatability R	≤ 5%
Hysteresis	≤ 15%
Ambient temperature range	-25...+80°C
Polution Degree	3
Time delay before availability	≤ 10ms
Particular characteristics	pressure rated to 500 bar

Mechanical Data

Measurements BxHxT or DxT	M12x1 x 93mm
Housing material	1.4104
Material of sensing face	EP (Duroplast)
Degree of protection	IP68 acc. BWN Pr 20IP
Connection	Connector S4 (M12)
Schock: Halfsinus, 30 gn, 11ms	
Vibration: 55 Hz, 1mm Amplitude, 3 x 30 Minutes	

Electrical Data

Current type	DC
Wiring	3-Wire
switching function	normally-open
Output signal	PNP
Rated operational voltage	24 DCV
Rated operational current	200mA
Supply voltage	10...30 DCV
Ripple	≤ 15%
max. switching frequency	1000Hz
No-load supply current	≤ 10/≤ 1mA
Off-state current	≤ 10µA
Voltage drop	≤ 1.5/-V
Short circuit protection	yes
Protected against polarity reversal	yes

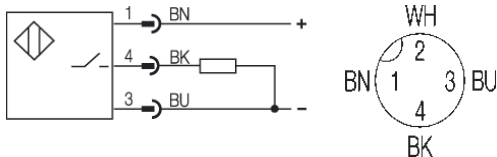

Utilization categories
 Insulation class

DC 13

Datasheet number:

Definitions see general catalog.
 If not otherwise noted, ratings according to
 IEC 60947-5-2 (DIN EN60947-5-2)

Balluff GmbH
 Schurwaldstrasse 9
 73765 Neuhausen a.d.F.
 Phone (07158) 173-0 Fax (07158) 5010

Datenblatt by CD-ROM - 04/2007

BALLUFF
 sensors worldwide